

# Rectifier Diodes

# 100V

V <sub>RM</sub> (V)	Package	Part Number	I <sub>F</sub> (AV) (A) ( ) is with Heatsink	I <sub>FSM</sub> (A)	T <sub>J</sub> (°C)	T <sub>stg</sub> (°C)	V <sub>F</sub> (V) max	I <sub>F</sub> (A)	I <sub>R</sub> (μA)	I <sub>R</sub> (H) (μA)	R <sub>th(j-l)</sub> R <sub>th(j-c)</sub> (°C/W)	Mass (g)	Fig. No.	Page where characteristic curve is shown
				50Hz Half-cycle Sinewave Single Shot					V <sub>R</sub> = V <sub>RM</sub> max	V <sub>R</sub> = V <sub>RM</sub> max				
100	Axial	EM 1Y	1.0	45	-40 to +150	0.97	1.0	10	50	100	17	0.3	<b>1</b>	48
		RM 4Y	1.7 (3.0)	200	-40 to +150	0.95	3.0	10	50	100	8	1.2	<b>2</b>	50
	Center-tap	FMM-31S, R	20	120	-40 to +150	1.1	10	10	100	100	2.0	5.5	<b>3</b>	51
	Bridge	RBV-401	4.0	80	-40 to +150	1.05	2.0	10	100	100	5.0	4.05	<b>4</b>	51
		RBV-601	6.0	120	-40 to +150	1.0	3.0	10	100	100	3.0	6.45	<b>5</b>	52

## External Dimensions Flammability: UL94V-0 or Equivalent (Unit: mm)

**1**

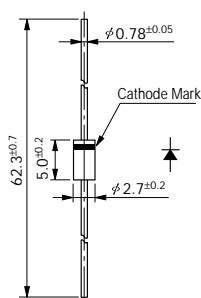

**2**

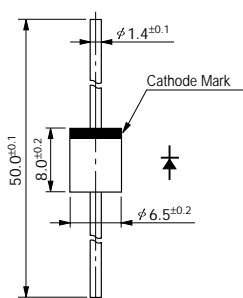

**3**

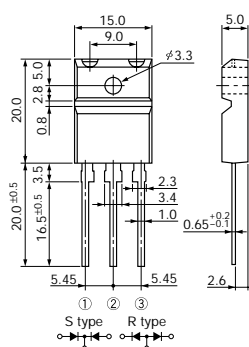

**4**

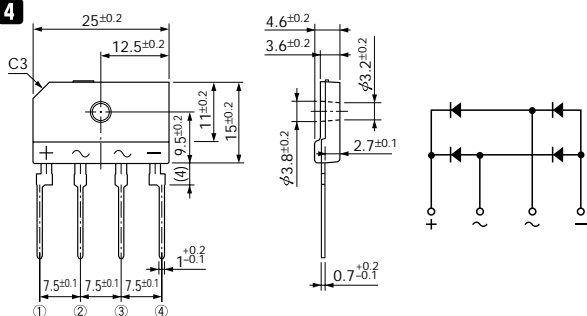

**5**

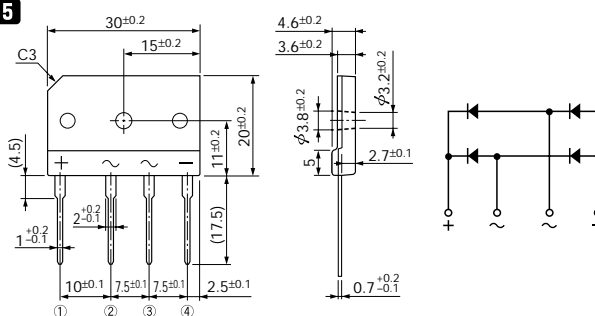

# Characteristic Curves Rectifier Diodes

## RBV-406H

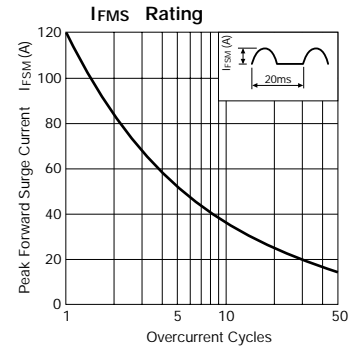
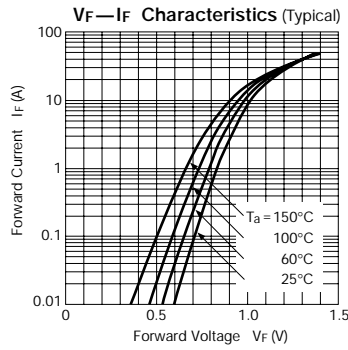
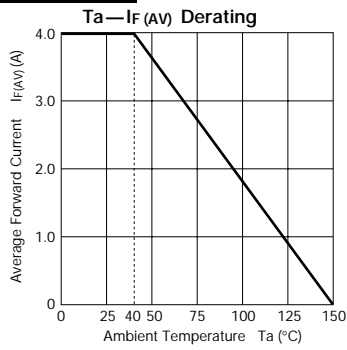

## RBV-601, 602

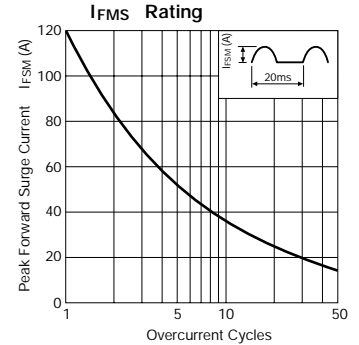
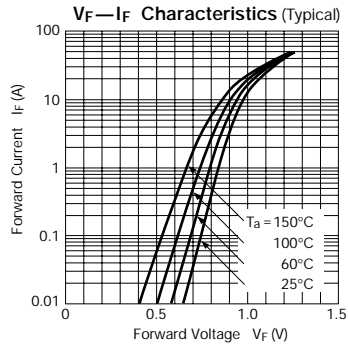
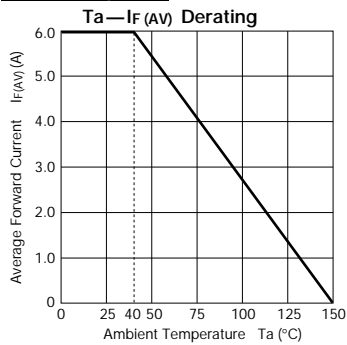

## RBV-604, 606

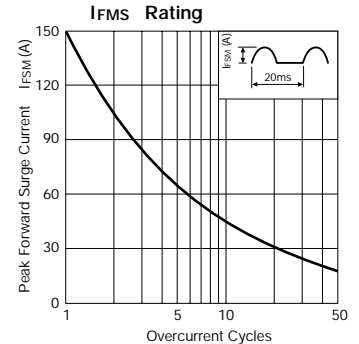
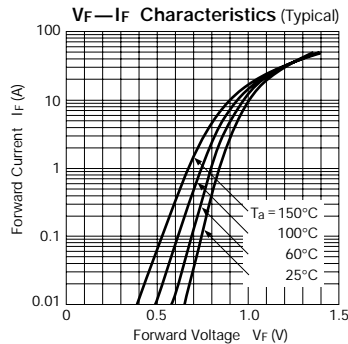
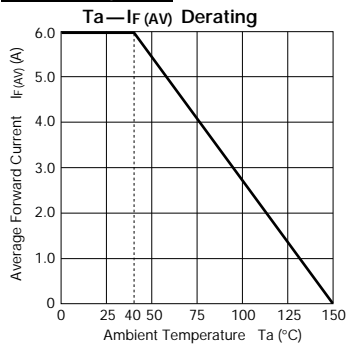

## RBV-608

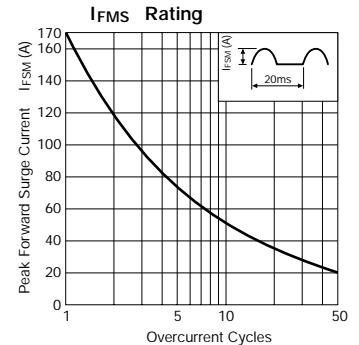
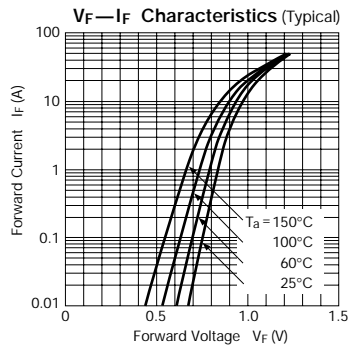
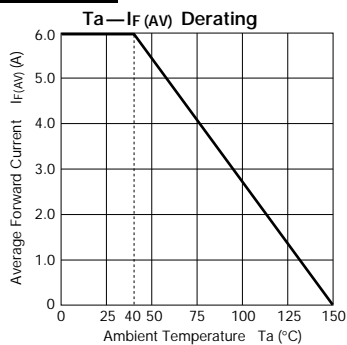

## RBV-606H

